

MULTI-SWING Series
 Profile Drawing

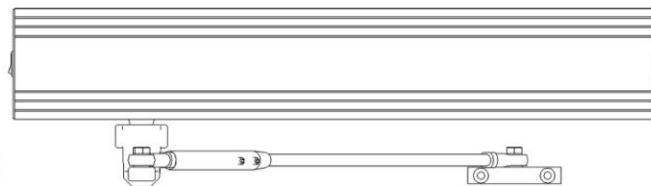
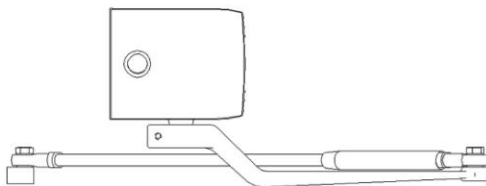
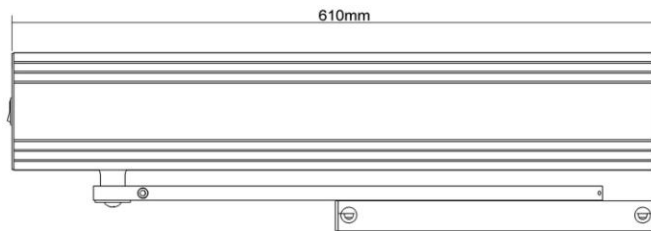
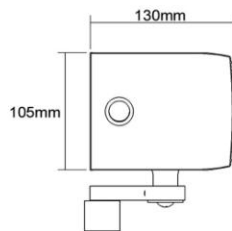
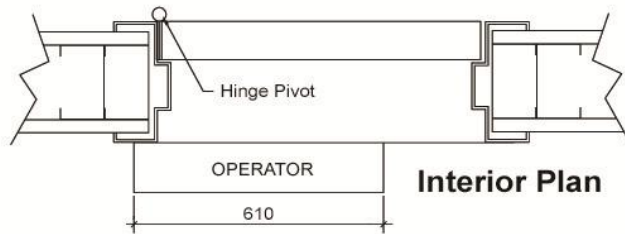
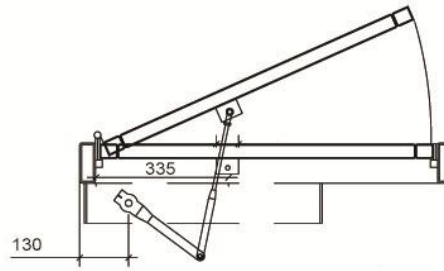
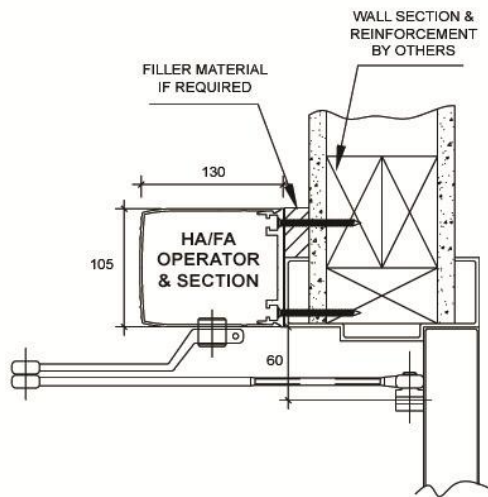

Copyright © 2012 MICOM Autodoor

The contents of the document are the sole property of MICOM Autodoor. The direct or indirect sales, copying, scanning, publication, modification or adaptation of any part of this document is prohibited without written consent of MICOM Autodoor. The company reserves the right to change this document without notice. E. & O. E.